



STAIRVILLE

AFH-600
hazer

Musikhaus Thomann
Thomann GmbH
Hans-Thomann-Straße 1
96138 Burgebrach
Germany
Telephone: +49 (0) 9546 9223-0
E-mail: info@thomann.de
Internet: www.thomann.de

13.02.2018, ID: 306309 (V2)

Table of contents

1	General notes.....	4
2	Safety instructions.....	7
3	Features.....	14
4	Installation.....	15
5	Starting up.....	16
6	Connections and operating elements.....	19
7	Operating.....	24
8	Technical specifications.....	30
9	Plug and connection assignments.....	31
10	Troubleshooting.....	32
11	Cleaning.....	34
12	Protecting the environment.....	36

1 General notes





This user manual contains important information on safe operation of the device. Read and follow all safety notes and all instructions. Save this manual for future reference. Make sure that it is available to all persons using this device. If you sell the device to other users, be sure that they also receive this manual.

Our products are subject to a process of continuous development. We therefore reserve the right to make changes without notice.

Symbols and signal words

This section provides an overview of the symbols and signal words used in this user manual.

Signal word	Meaning
DANGER!	This combination of symbol and signal word indicates an immediate dangerous situation that will result in death or serious injury if it is not avoided.
WARNING!	This combination of symbol and signal word indicates a possible dangerous situation that can result in death or serious injury if it is not avoided.
CAUTION!	This combination of symbol and signal word indicates a possible dangerous situation that can result in minor injury if it is not avoided.
NOTICE!	This combination of symbol and signal word indicates a possible dangerous situation that can result in material and environmental damage if it is not avoided.

Warning signs	Type of danger
 A yellow triangular warning sign with a black border and a black lightning bolt symbol in the center.	Warning – high-voltage.
 A yellow triangular warning sign with a black border and a black flame symbol in the center.	Warning – flammable substances.
 A yellow triangular warning sign with a black border and a black 'X' symbol in the center.	Warning – harmful or irritating substances.
 A yellow triangular warning sign with a black border and a black exclamation mark symbol in the center.	Warning – danger zone.

2 Safety instructions

Intended use

This device is intended to be used to produce fine haze by vaporising fog fluid. Use the device only as described in this user manual. Any other use or use under other operating conditions is considered to be improper and may result in personal injury or property damage. No liability will be assumed for damages resulting from improper use.

This device may be used only by persons with sufficient physical, sensorial, and intellectual abilities and having corresponding knowledge and experience. Other persons may use this device only if they are supervised or instructed by a person who is responsible for their safety.

Safety



DANGER!

Danger for children

Ensure that plastic bags, packaging, etc. are disposed of properly and are not within reach of babies and young children. Choking hazard!

Ensure that children do not detach any small parts (e.g. knobs or the like) from the unit. They could swallow the pieces and choke!

Never let children unattended use electrical devices.



DANGER!

Electric shock caused by high voltages inside

Within the device there are areas where high voltages may be present. Never remove any covers.

There are no user-serviceable parts inside.

Do not use the device if covers, protectors or optical components are missing or damaged.



DANGER!

Electric shock caused by short-circuit

Always use proper ready-made insulated mains cabling (power cord) with a protective contact plug. Do not modify the mains cable or the plug. Failure to do so could result in electric shock/death or fire. If in doubt, seek advice from a registered electrician.



WARNING!

Risk of burns from flammable liquids

The use of flammable liquids in this device may cause severe burns and damage to property.

Always use approved fog fluids. Never fill flammable liquids into the tank of the device.



WARNING!

Risk of slipping caused by condensation

Fog machines can produce condensation. Do not direct the fog to floors. Floors and surfaces can become slippery by condensed fog.

Check at regular intervals whether it is possible to walk on the floors without a slipping hazard, and, if necessary, remove the condensation.



WARNING!

Health hazard caused by fog fluid handling

Fog fluid does contain glycols complying with the regulations for foodstuffs. However, it may be harmful if swallowed.

Do not induce vomiting. Seek medical advice immediately. Keep fog fluid in a safe place. If the fog fluid comes into contact with eyes rinse thoroughly with water.



CAUTION!

Possible respiratory problems

The device can be operated safely only with the approved fog fluid. The use of other fluids can release toxic gases. Claims for damages caused by the use of non-approved fluids shall be excluded.

Do not create fog in closed or poorly ventilated areas.

Do not expose persons with health problems (such as allergic respiratory conditions, asthma) to artificial fog.



NOTICE!

Risk of fire

Do not block areas of ventilation. Do not install the device near any direct heat source. Keep the device away from naked flames.



NOTICE!

Operating conditions

This device has been designed for indoor use only. To prevent damage, never expose the device to any liquid or moisture. Avoid direct sunlight, heavy dirt, and strong vibrations.



NOTICE!

Power supply

Before connecting the device, ensure that the input voltage (AC outlet) matches the voltage rating of the device and that the AC outlet is protected by a residual current circuit breaker. Failure to do so could result in damage to the device and possibly injure the user.

Unplug the device before electrical storms occur and when it is unused for long periods of time to reduce the risk of electric shock or fire.

General information about how to safely operate fog machines and hazers

The device was designed for use in professional event technology and works reliably when used properly. Observe the following information:

- Follow all warnings in these operating instructions.
- Never leave the device running without supervision.
- The device is not suitable for use in private households or as a child's toy.
- Place the device on a stable, fire-proof basis that is at least twice as large as the device.
- Maintain a safety distance of 1 m to flammable materials.
- The device is not intended for suspended assembly (the so-called "flying operation").

- During operation, ensure that the visibility in the room does not fall below 2 m so that everyone in the room can still orient themselves safely.
- The haze or mist generated by the device may trigger smoke alarms.

3 Features

This hazer is suitable to be used in clubs, bars, discotheques and on stages.

Special features of the device:

- Compact design
- Suitable for mobile use
- Large liquid container for the fog liquid

4 Installation

Unpack and carefully check that there is no transportation damage before using the unit. Keep the equipment packaging. To fully protect the device against vibration, dust and moisture during transportation or storage use the original packaging or your own packaging material suitable for transport or storage, respectively.

The unit requires 20 cm clearance on the sides and above. Place the unit on a flat, stable surface. The device must not be positioned with more than 15° inclination during operation.

5 Starting up

Create all connections while the device is off. Use the shortest possible high-quality cables for all connections. Take care when running the cables to prevent tripping hazards.

Connections in DMX mode

Connect the DMX input of the device to the DMX output of a DMX controller or another DMX device. Connect the output of the first DMX device to the input of the second one, and so on to form a daisy chain. Always ensure that the output of the last DMX device in the daisy chain is terminated with a resistor ($110\ \Omega$, $\frac{1}{4}\ \text{W}$).

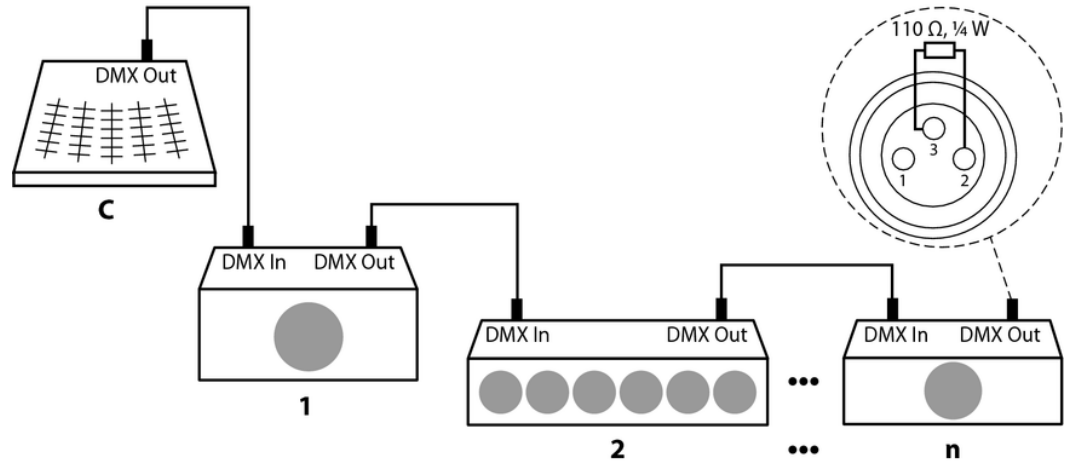

Connections in 'Master / Slave' mode

When you configure a group of devices in 'Master / Slave' mode, the first unit will control the others. Connect the DMX output of the master device to the DMX input of the first slave device. Then connect the DMX output of the first slave device to the DMX input of the second slave device and so on.

6 Connections and operating elements

Front panel

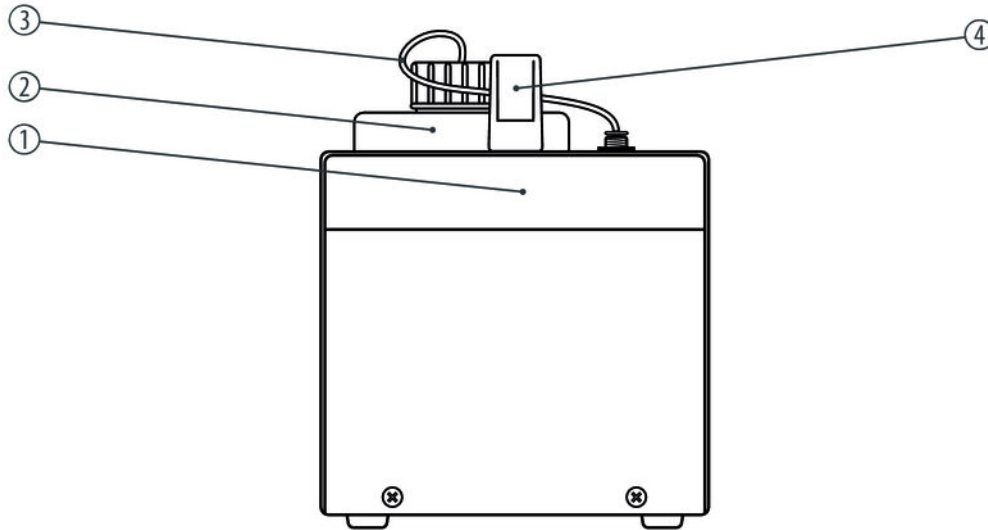

AFH-600

1	Haze aperture
2	Fog fluid container with screw-cap
3	Fog fluid feed line from fluid container to vaporiser
4	Carrying handle

Rear panel

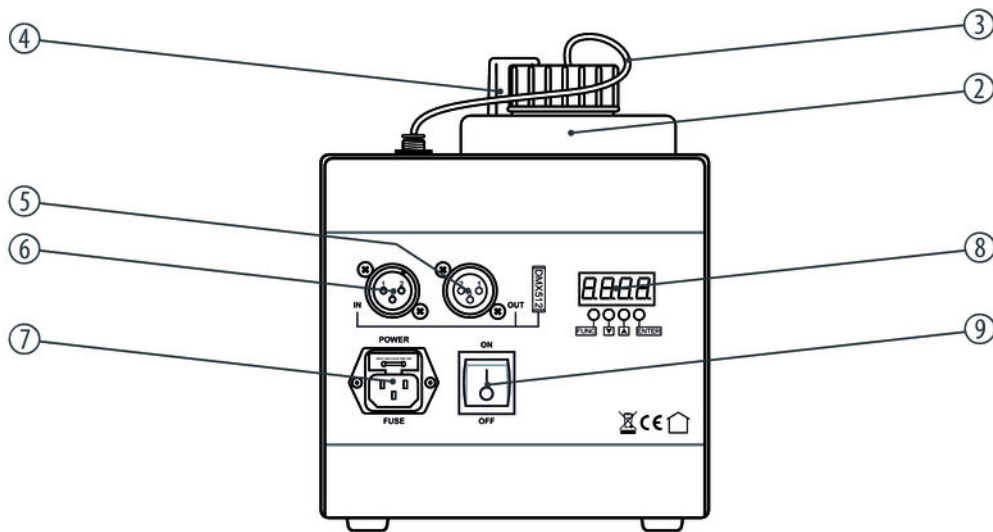

AFH-600

2	Fog fluid container with screw-cap
3	Fog fluid feed line from fluid container to vaporiser
4	Carrying handle
5	<i>[OUT]</i> DMX output
6	<i>[IN]</i> DMX input.
7	<i>[POWER]</i> Plug for mains cable with fuse holder
8	Display and control panel
	<i>[FUNC]</i> button Opens the main menu.
	▼ button Decreases the displayed value by one.

	▲ button Increases the displayed value by one.
	[ENTER] button Chooses between the options of the selected mode
9	[ON / OFF] Power on/off switch. Turns the device on and off.

7 Operating

Filling the unit



NOTICE!

Possible damages caused by unsuitable fog fluid

Fog liquids not approved by the manufacturer may permanently damage the unit.

Only use the fog fluids listed on www.thomann.de and follow their instructions for use.

First, make sure the unit is switched off.

Open the screw-cap of the liquid container and fill in the fog fluid. Make sure that no fluid is spilled or gets into the device. The easiest way is using a funnel. The container capacity is 2.3 litre.

Screw the cap firmly back on.

Turning the unit on



NOTICE!

Fire hazard

Do not operate the machine unattended.

Connect the device to the power grid and turn it on with the main switch. The unit is heating up and the display shows 'UP'.

As soon as the required operating temperature is reached, the display shows a value between 'F001' and 'F100'. The device is now operational.

Operating modes

The device supports the following operating modes that you can select with the buttons on the device:

- Manual control
- Master / Slave mode
- DMX control

The haze volume that you have set either directly on the device, on the 'Master' or with your DMX controller is uniformly ejected in all modes.

Main menu

Press *[FUNC]* to activate the main menu and select an operating mode.

When the display is flashing, use the arrow keys to change the respectively displayed value. When the display shows the desired value, press *[ENTER]*. To return to the main menu without any changes, press *[FUNC]* or wait a minute.

All previous settings are retained even when you disconnect the device from the mains.

Operating mode 'Manual control'

This mode can only be selected when no DMX controller is connected and turned on.

Press *[FUNC]* repeatedly until the display shows 'out'. Press *[ENTER]*. Now you can use the arrow keys to adjust the desired haze amount between 'F001' (no haze output) and 'F100' (maximum haze output). Press *[ENTER]* to confirm.

To suspend haze output, press *[ENTER]*, the display shows 'read'. To resume haze output, press *[ENTER]* again. The display shows the last selected value again.

Operating mode 'Master / Slave'

This mode can only be selected when no DMX controller is connected and turned on.

Press *[FUNC]* repeatedly until the display shows 'SLNd'. Press *[ENTER]*. Now you can use the arrow keys to choose from the following options:

- 'NAsT': The device works as 'Master' and controls other devices that follow as 'Slave'.
- 'SLAu': The device follows as 'Slave' exactly the operation of the 'Master' to which it is connected.

Press *[ENTER]* to confirm and to start operation in 'Master / Slave' mode.

Operating mode 'DMX'

Press *[FUNC]* repeatedly until the display shows 'Addr'. Press *[ENTER]*. Now you can set the number of the first DMX channel to be used by the device (DMX address). Use the arrow keys to select a value between 1 and 512. Press *[ENTER]* to save the value and to start operation in 'DMX' mode.

Make sure that this number matches the configuration of your DMX controller.

DMX assignment

Channel	Value	Function
1	Setting the amount of haze	
	0...255	No haze output (0 %) to maximum haze output (100 %)

Turning the unit off

Turn off the power using the main switch. Transport the device only when it is completely cooled down. To avoid leaking fog fluid during transport, you should transport the device only with empty fluid container.

Menu overview

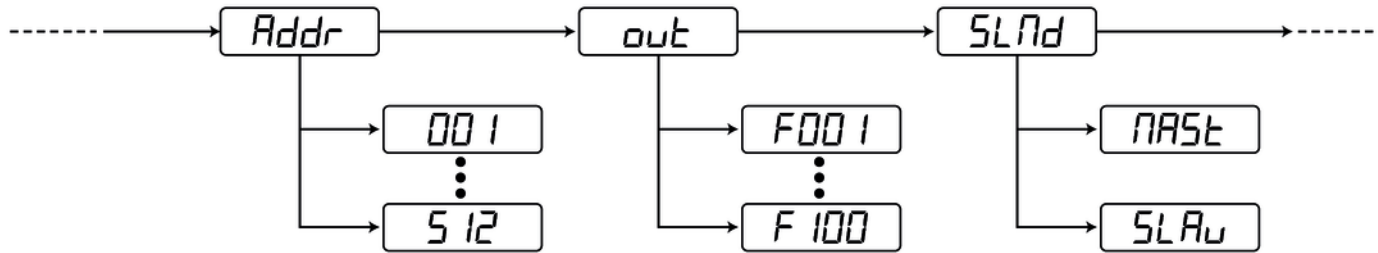

8 Technical specifications

Heater power	600 W
Haze output	approx. 850 m ³ /min
Fluid container capacity	2.3 l
Warm-up time	approx. 2 min
Operating supply voltage	AC 230 V ~ 50 Hz
Fuse	5 mm × 20 mm, 4 A, 250 V, fast-acting
Power consumption	1290 W
Dimensions (W × H × D)	290 mm × 450 mm × 265 mm (15.35in. × 5.31in. × 15.55in.)
Weight	5.5 kg

9 Plug and connection assignments

Introduction

This chapter will help you select the right cables and plugs to connect your valuable equipment so that a perfect light experience is guaranteed.

Please take our tips, because especially in 'Sound & Light' caution is indicated: Even if a plug fits into a socket, the result of an incorrect connection may be a destroyed DMX controller, a short circuit or 'just' a not working light show!

DMX connections

The unit offers a 3-pin XLR socket for DMX output and a 3-pin XLR plug for DMX input. Please refer to the drawing and table below for the pin assignment of a suitable XLR plug.



Pin	Configuration
1	Ground, shielding
2	Signal inverted (DMX-, 'cold signal')
3	Signal (DMX+, 'hot signal')

10 Troubleshooting

In the following we list a few common problems that may occur during operation. We give you some suggestions for easy troubleshooting:

Symptom	Remedy
The unit does not work	Check the mains connection and the main fuse.
No haze output	<ol style="list-style-type: none"> 1. Check the fluid level in the fog container. 2. Switch the device off and check the hose that leads into the fluid container for flow.
No response to the DMX controller	<ol style="list-style-type: none"> 1. Check the address settings and the DMX polarity. 2. Try using another DMX controller. 3. Check to see if the DMX cables run near or alongside to high voltage cables that may cause damage or interference to DMX interface circuits.

If the procedures recommended above do not succeed, please contact our Service Center. You can find the contact information at www.thomann.de.

11 Cleaning



NOTICE!

Possible damages caused by unsuitable cleaning agents

Cleaners not approved by the manufacturer may permanently damage the unit.

Only use the fog machine cleaners listed on www.thomann.de and follow their instructions for use.

Clean the appliance after every 30 operating hours, or if it was not in use for a longer period of time.

Procedure

1. ➤ Make sure that the device is turned off, disconnected from the mains and completely cooled down.
2. ➤ Position the unit in a well ventilated place.
3. ➤ Insert the suction hose of the hazer into the bottle with the fog machine cleaner.
4. ➤ Connect the device to the mains and switch it on with the main switch. The unit is heating up and the display shows 'UP'.

- 5.** ▶ As soon as the required operating temperature is reached, the display shows a value between 'F001' and 'F100'. The device is now operational.
Use the arrow keys to set the value 'F100' for maximum haze output and let the device produce haze for about 20 seconds.
- 6.** ▶ Insert the suction hose of the hazer back into the fog fluid container and let the device again produce haze for about 20 seconds. This will rinse the lines.
⇒ The cleaning is completed.

12 Protecting the environment

Disposal of the packaging material



For the transport and protective packaging, environmentally friendly materials have been chosen that can be supplied to normal recycling.

Ensure that plastic bags, packaging, etc. are properly disposed of.

Do not just dispose of these materials with your normal household waste, but make sure that they are collected for recycling. Please follow the notes and markings on the packaging.

Disposal of your old device



This product is subject to the European Waste Electrical and Electronic Equipment Directive (WEEE) in its currently valid version. Do not dispose with your normal household waste.

Dispose of this device through an approved waste disposal firm or through your local waste facility. When discarding the device, comply with the rules and regulations that apply in your country. If in doubt, consult your local waste disposal facility.



Musikhaus Thomann · Hans-Thomann-Straße 1 · 96138 Burgebrach · Germany · www.thomann.de